

1st+2nd Strait Through Press

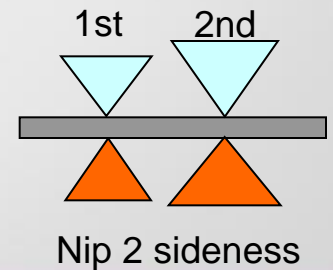

1st Strait Through Press + 2nd Inverse Press

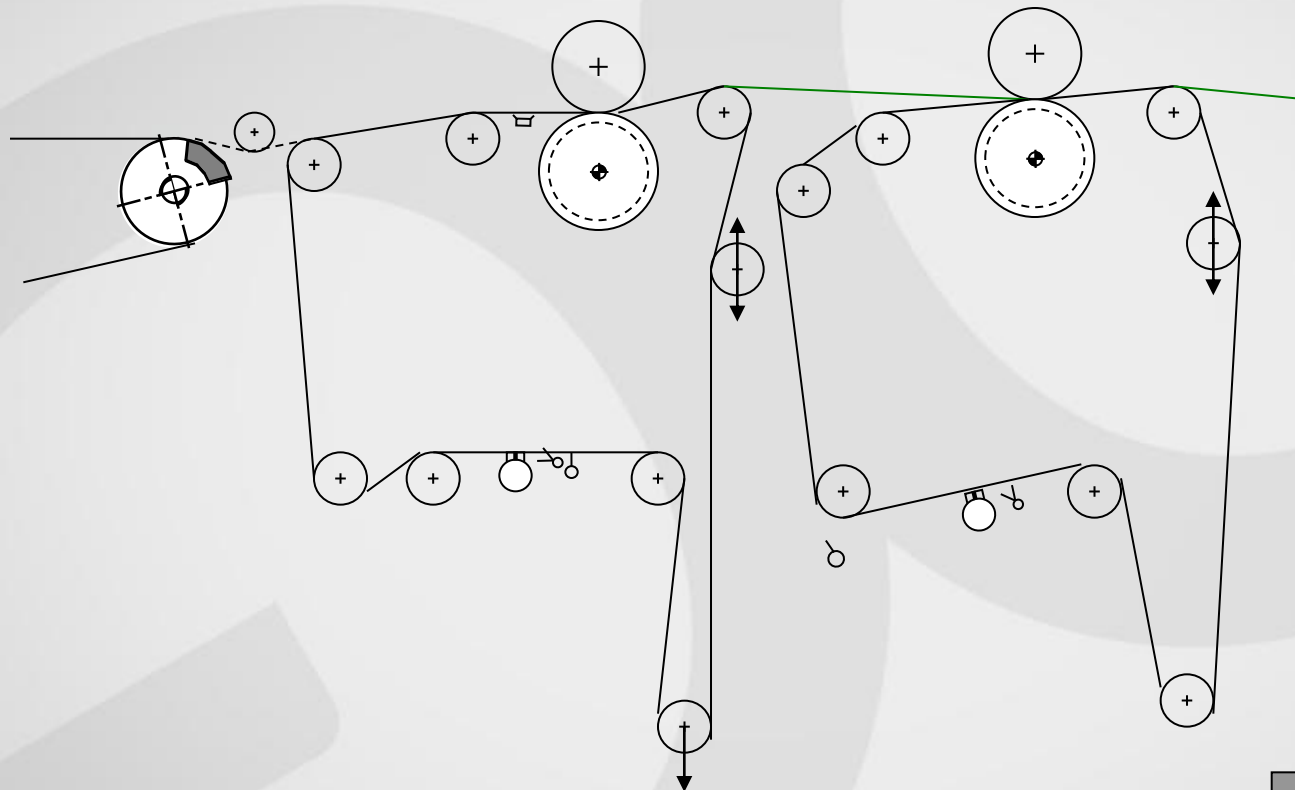
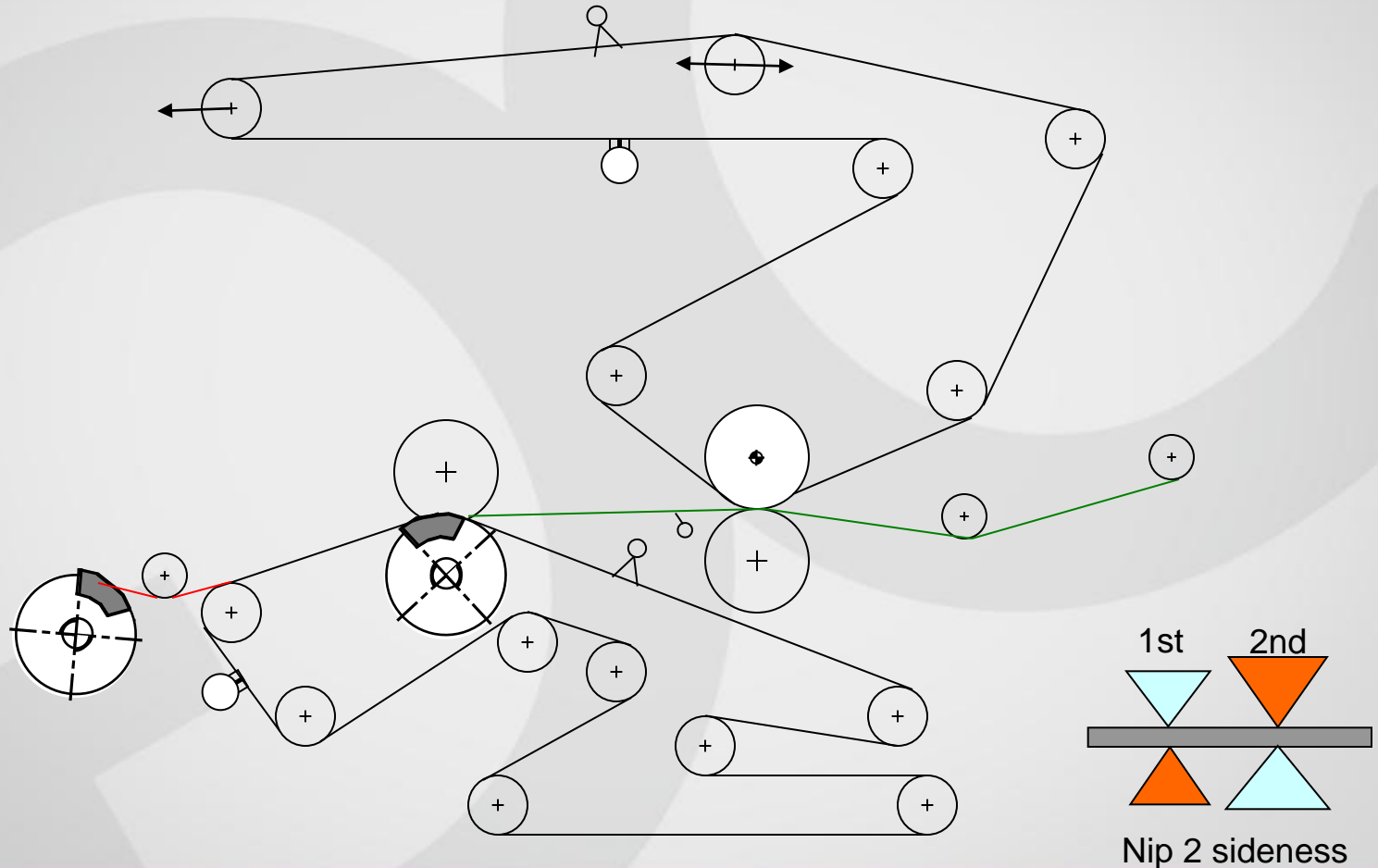

1st+2nd Strait Through Press +3rd Reverse Press

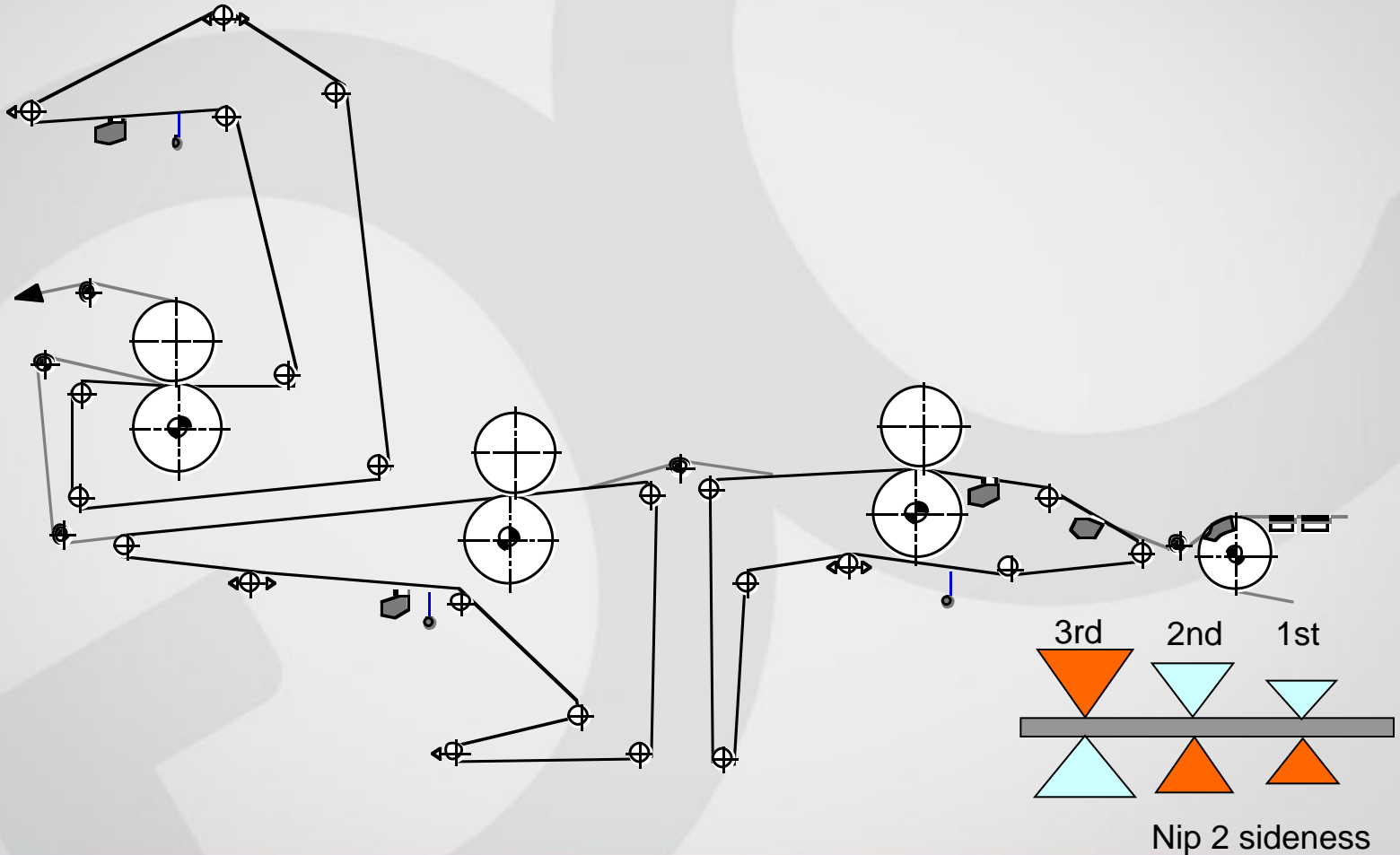

Pick-up Unipress + 2nd Strait Through Press

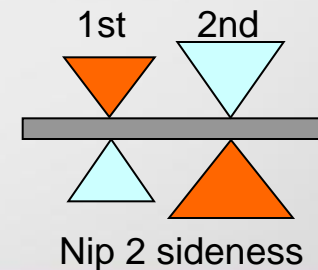
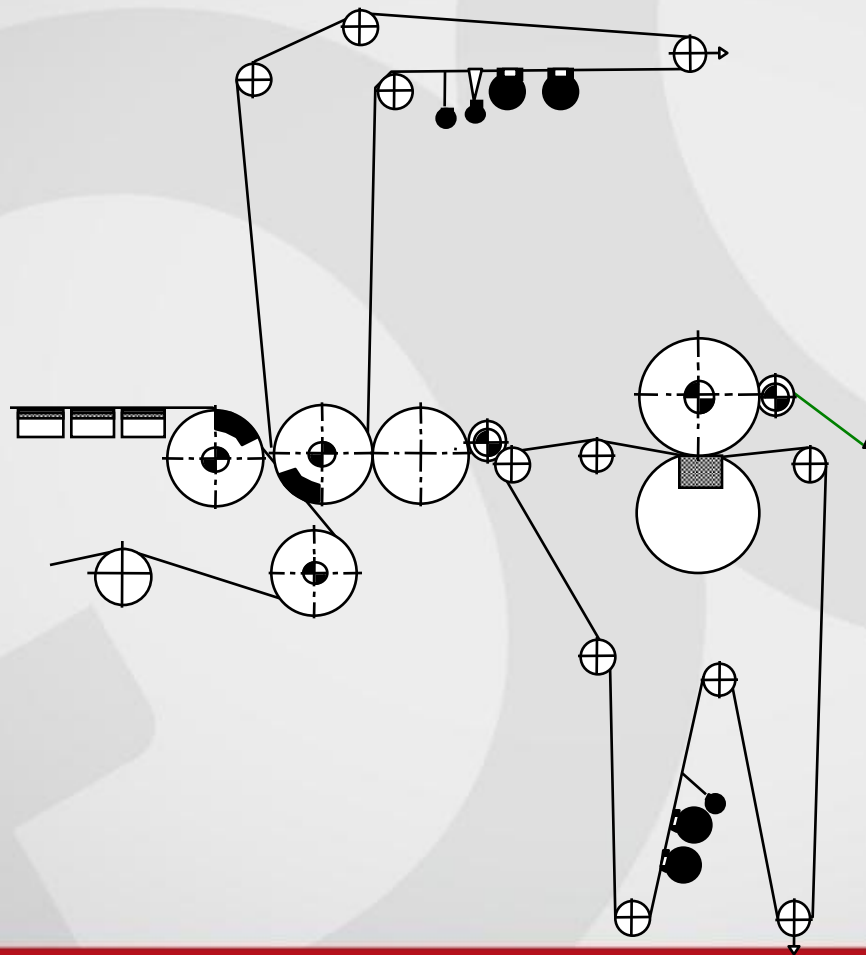

Bi-nip+3rd Strait Through Press (Controlled Crown) (News/Graphic)

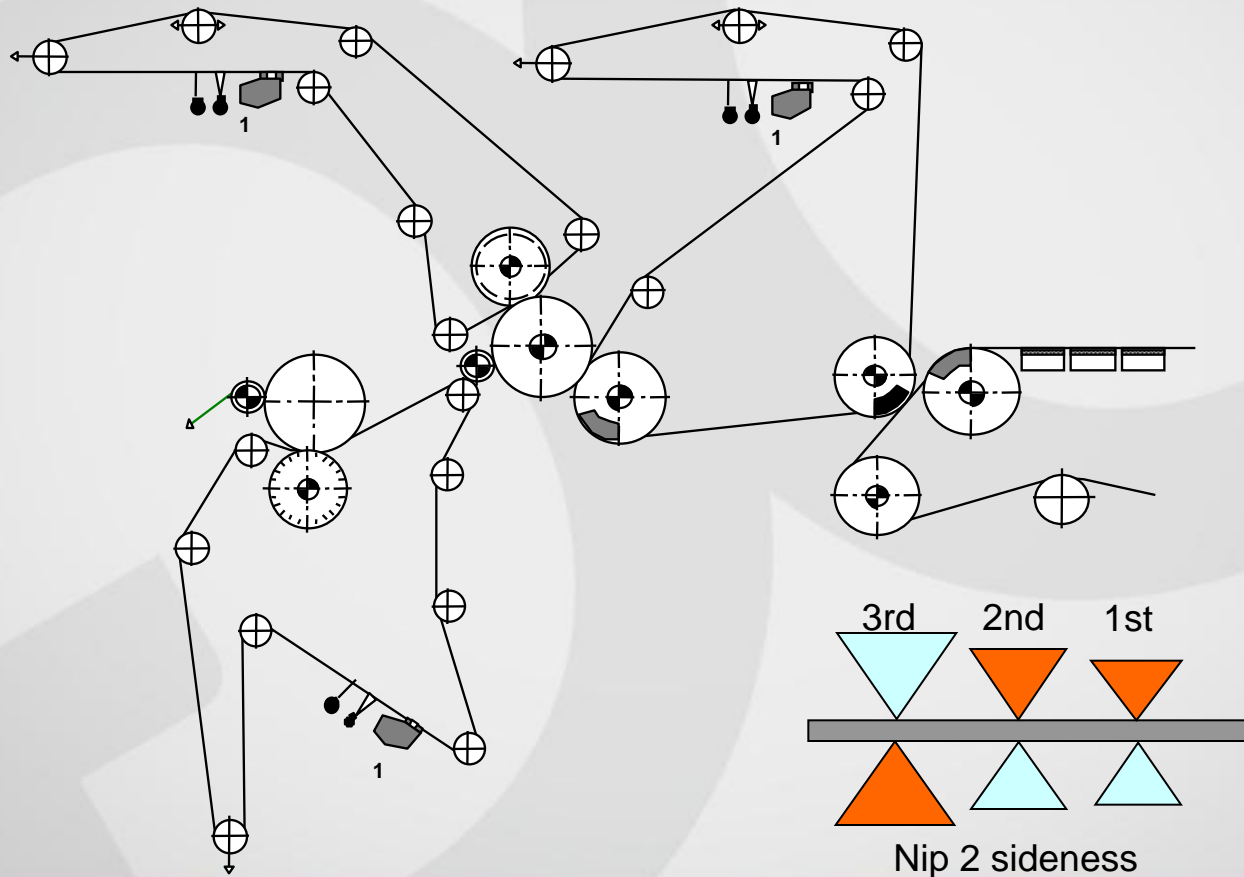

Tri-nip+4th Strait Through (Controlled Crown) (News/Graphic)

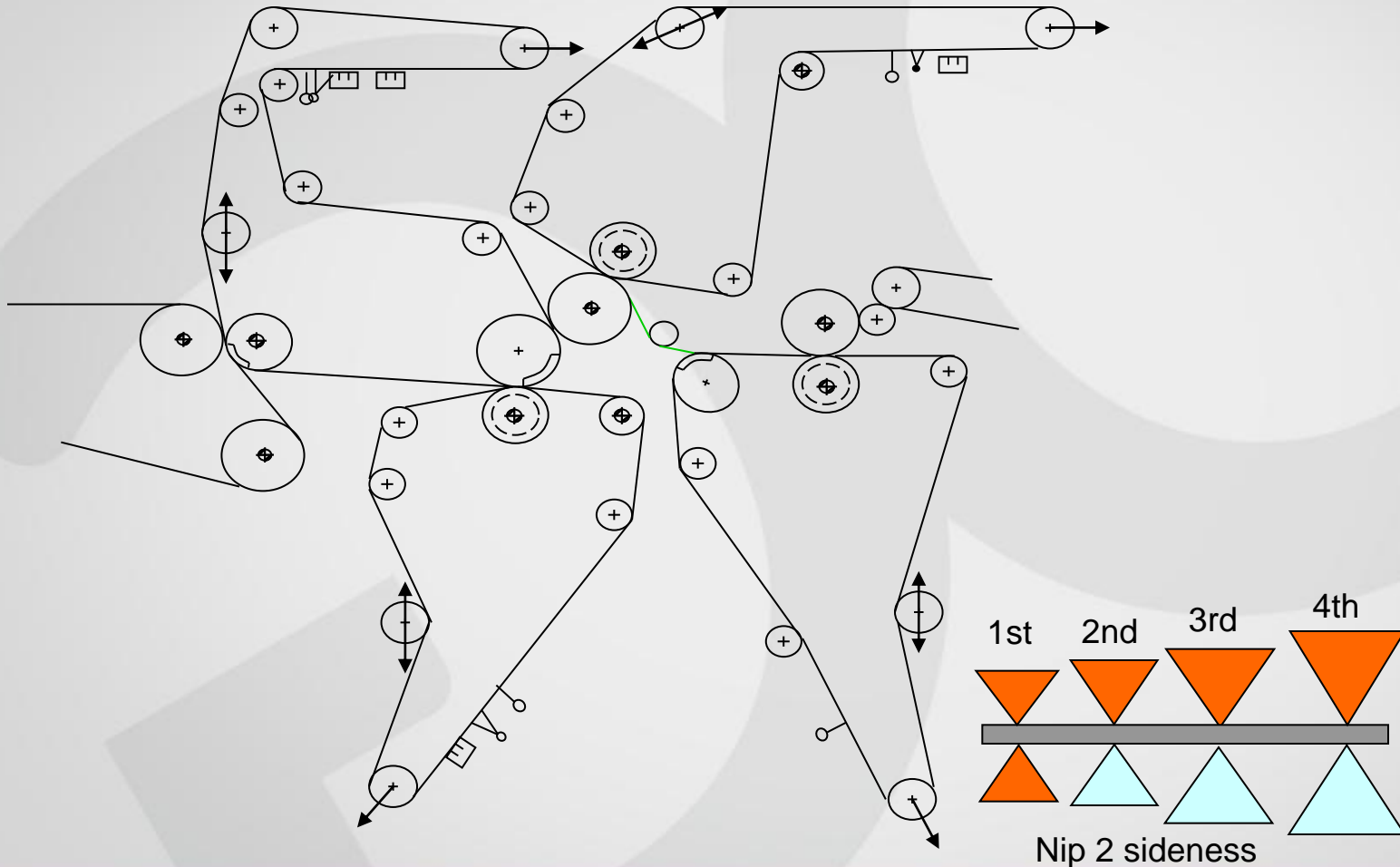

Tri-nip+4th Strait Through (Controlled Crown) (News/Graphic)

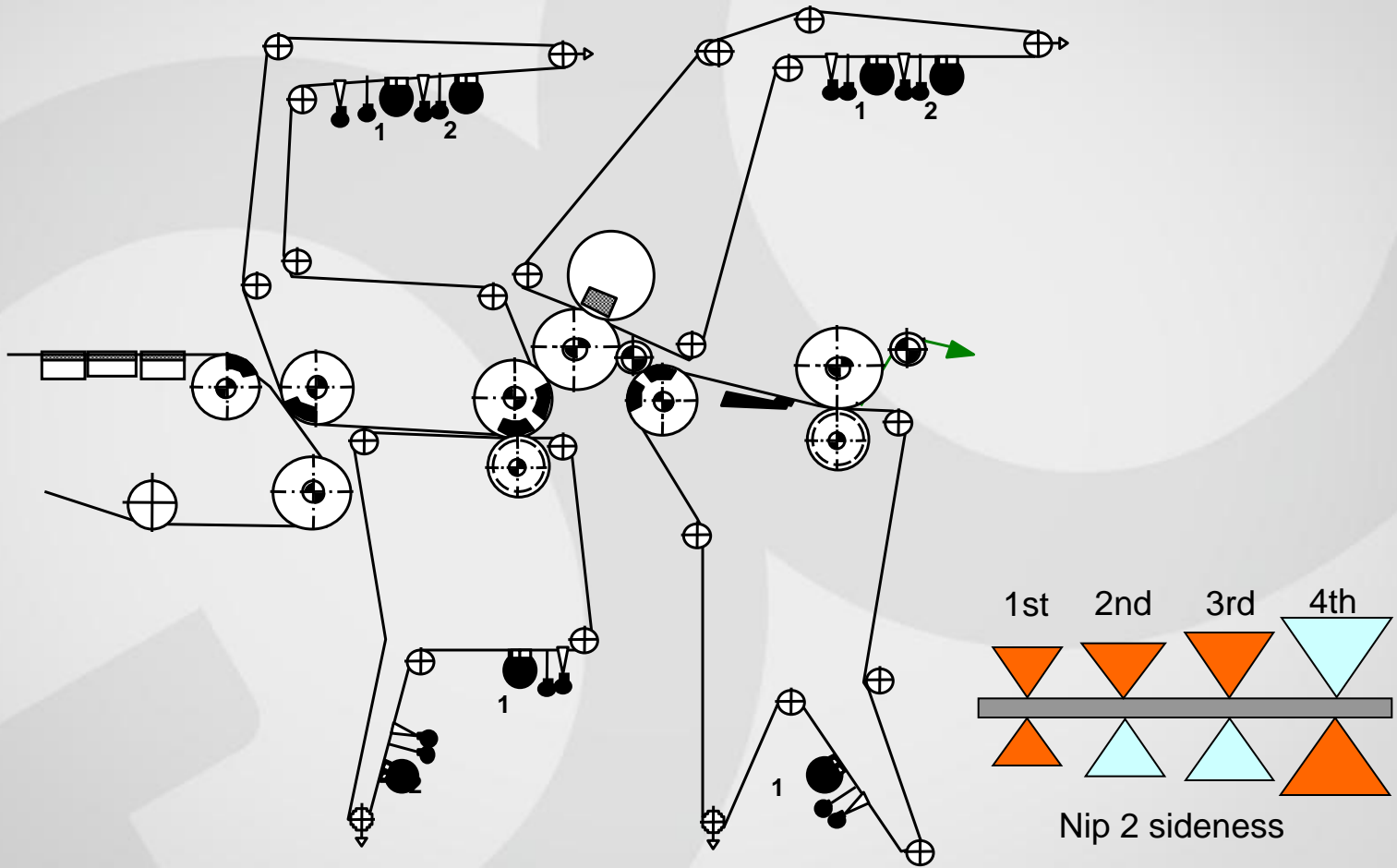

Bi-vent+3rd Strait Through Press (Controlled Crown) (Graphic)

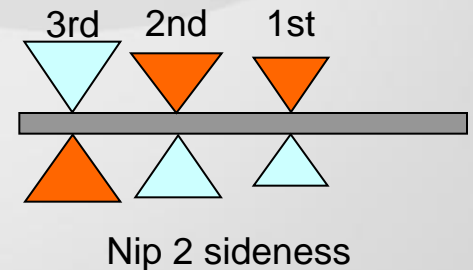
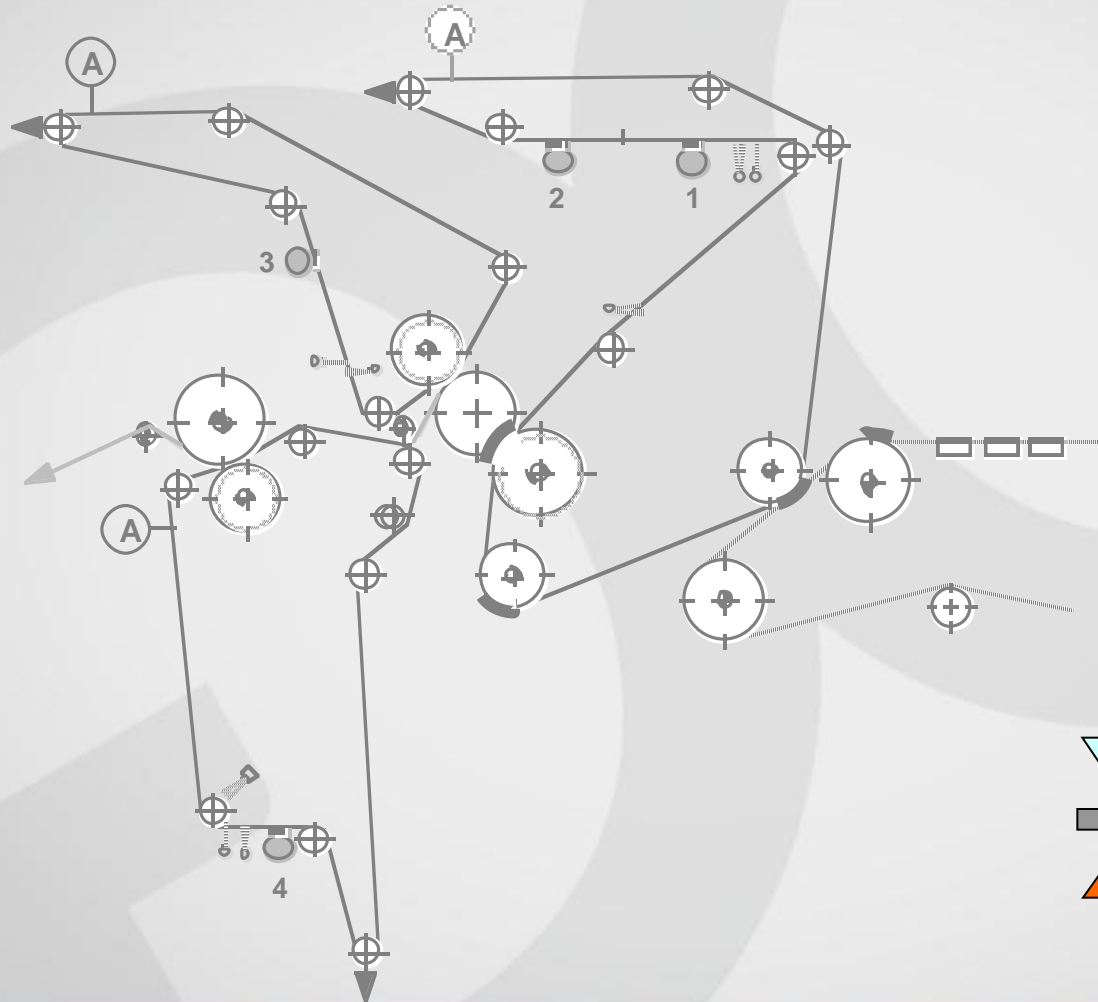

Tri-vent+4th Strait Through Press (Controlled Crown) (Graphic)

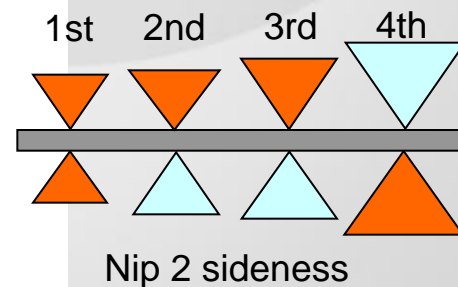
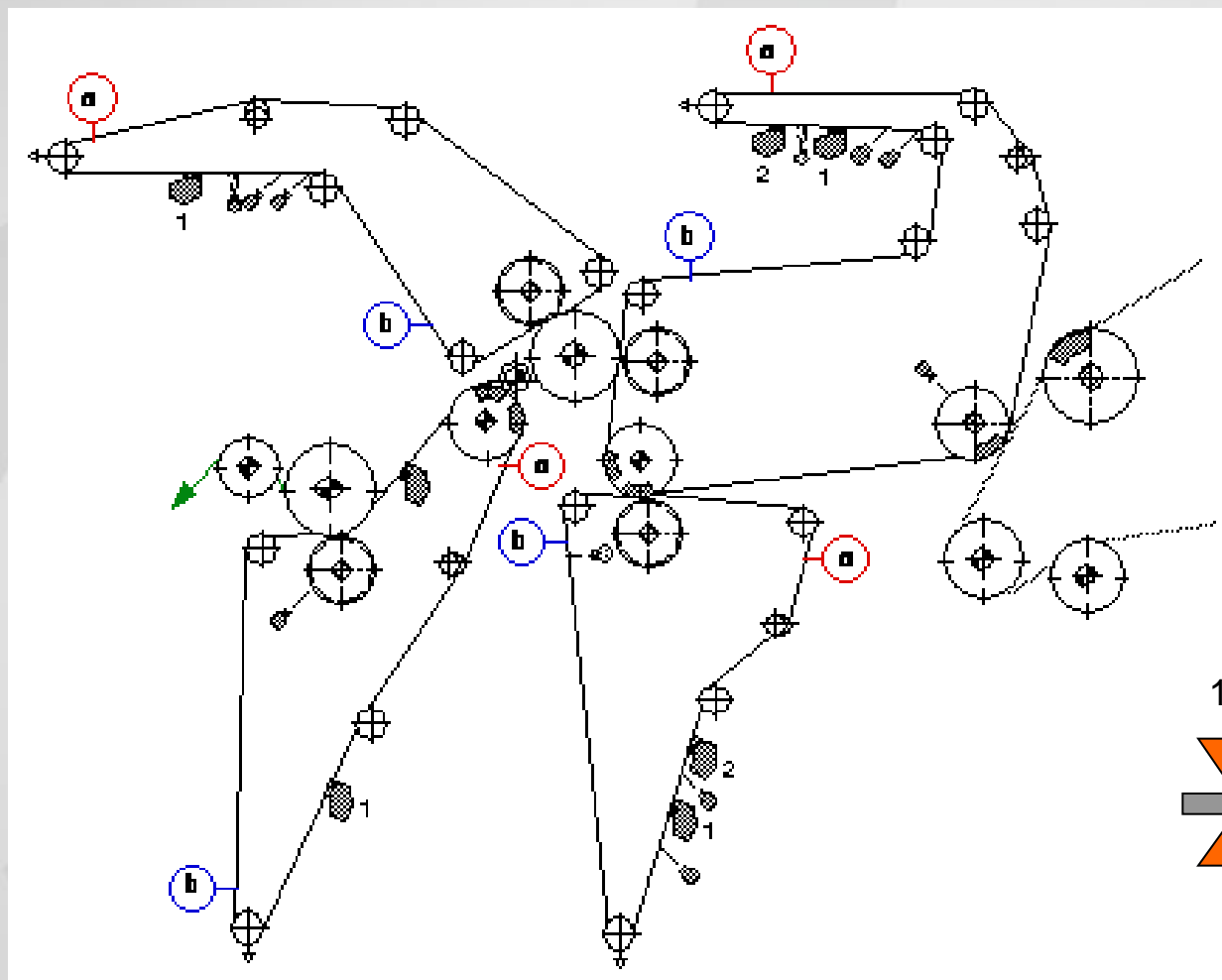

1st+2nd nip Bi-felted (OptiConcept)

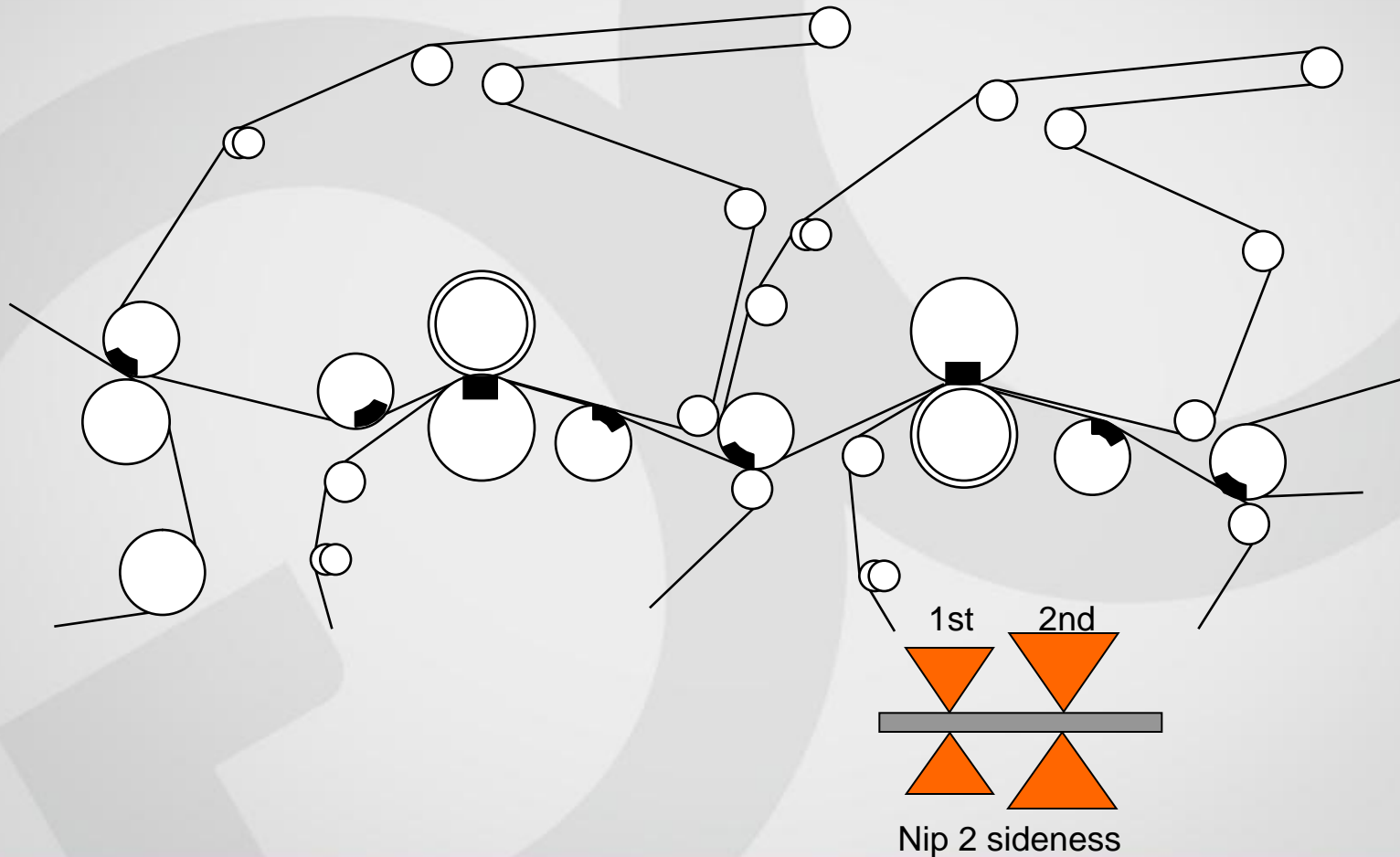

1st+2nd nip Bi-felted With Transbelt (OptiConcept)

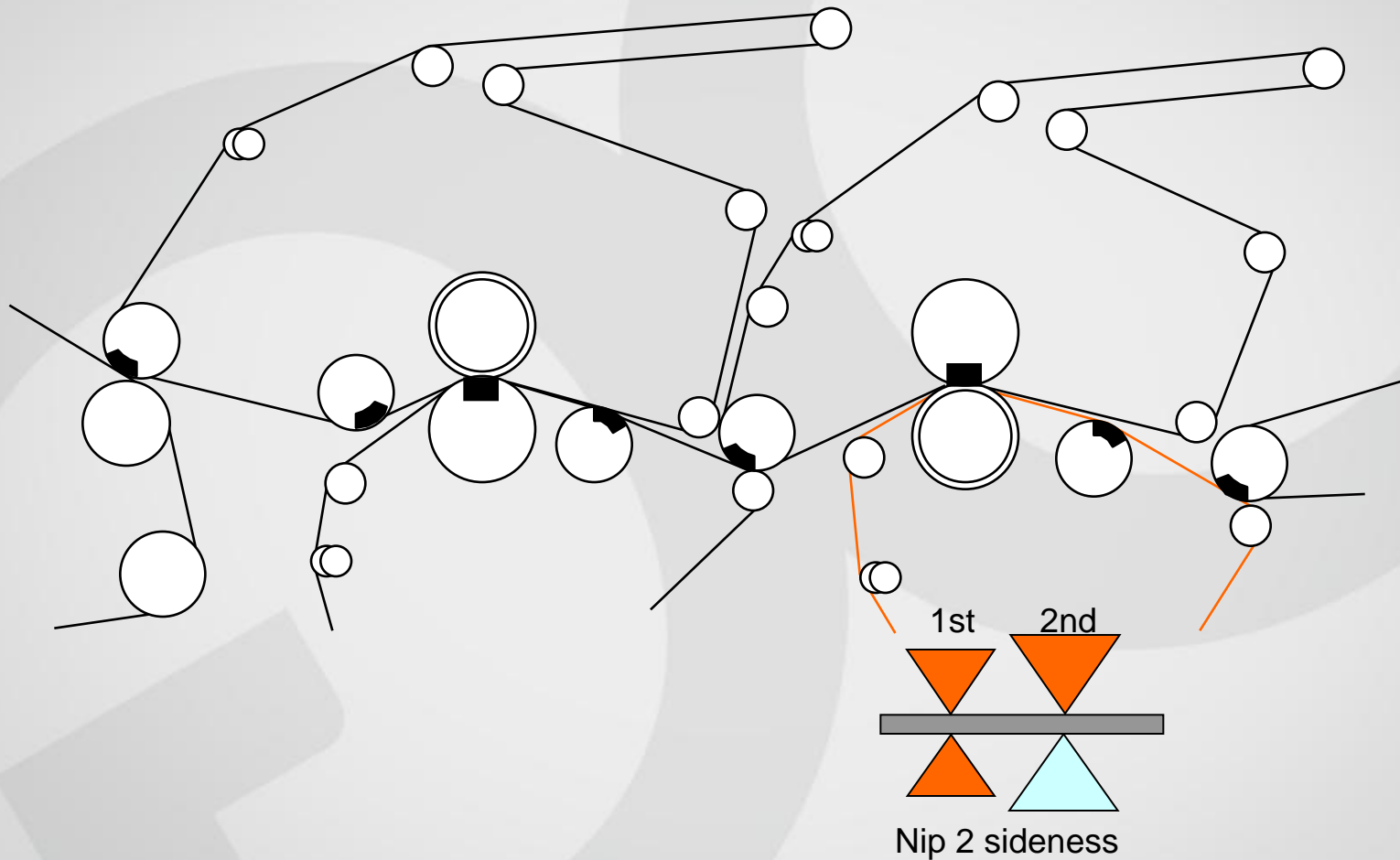

Yankee Pick-up (Tissue)

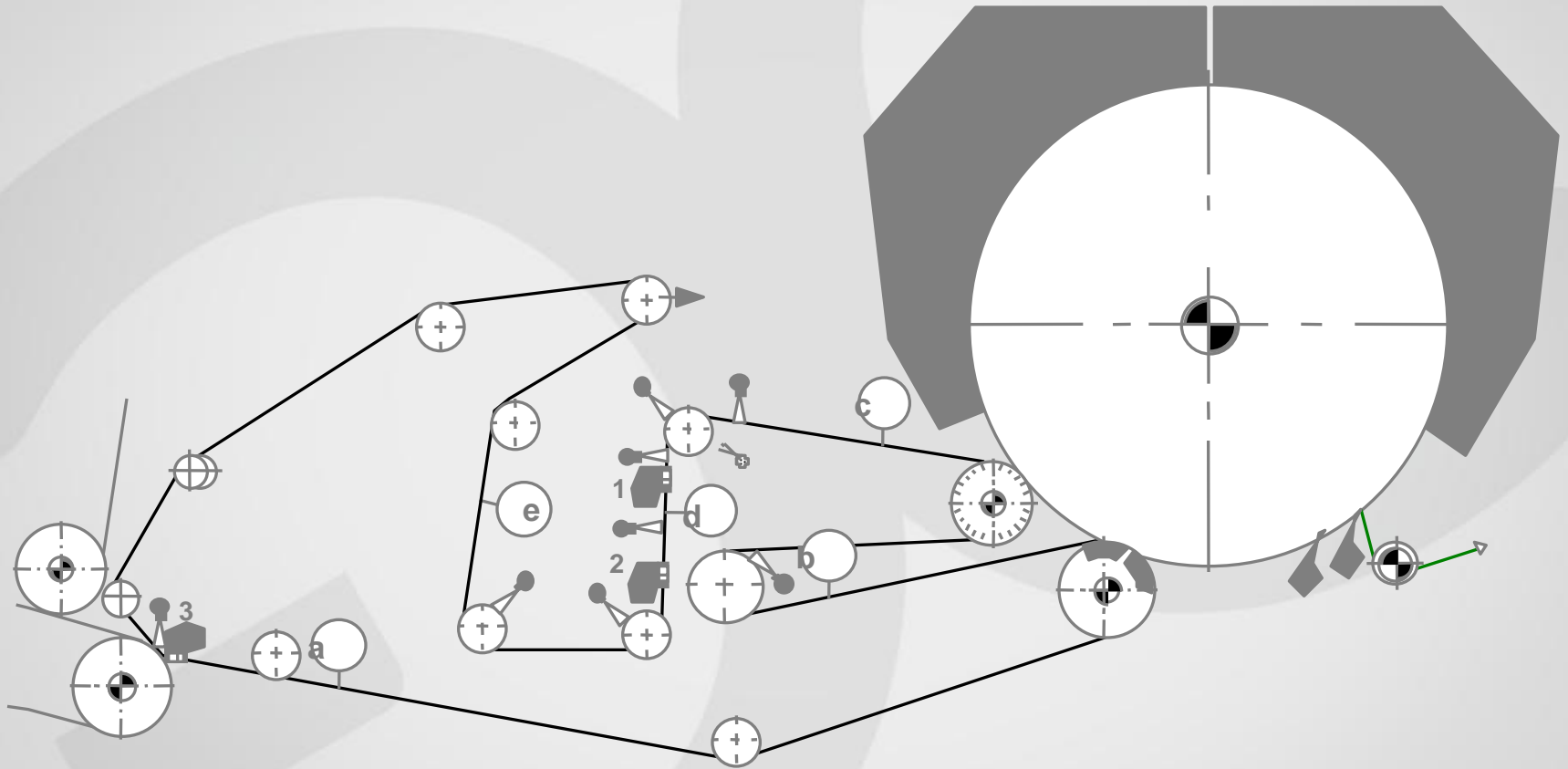

Yankee Crescent-Former (Procter & Gamble) (Tissue)

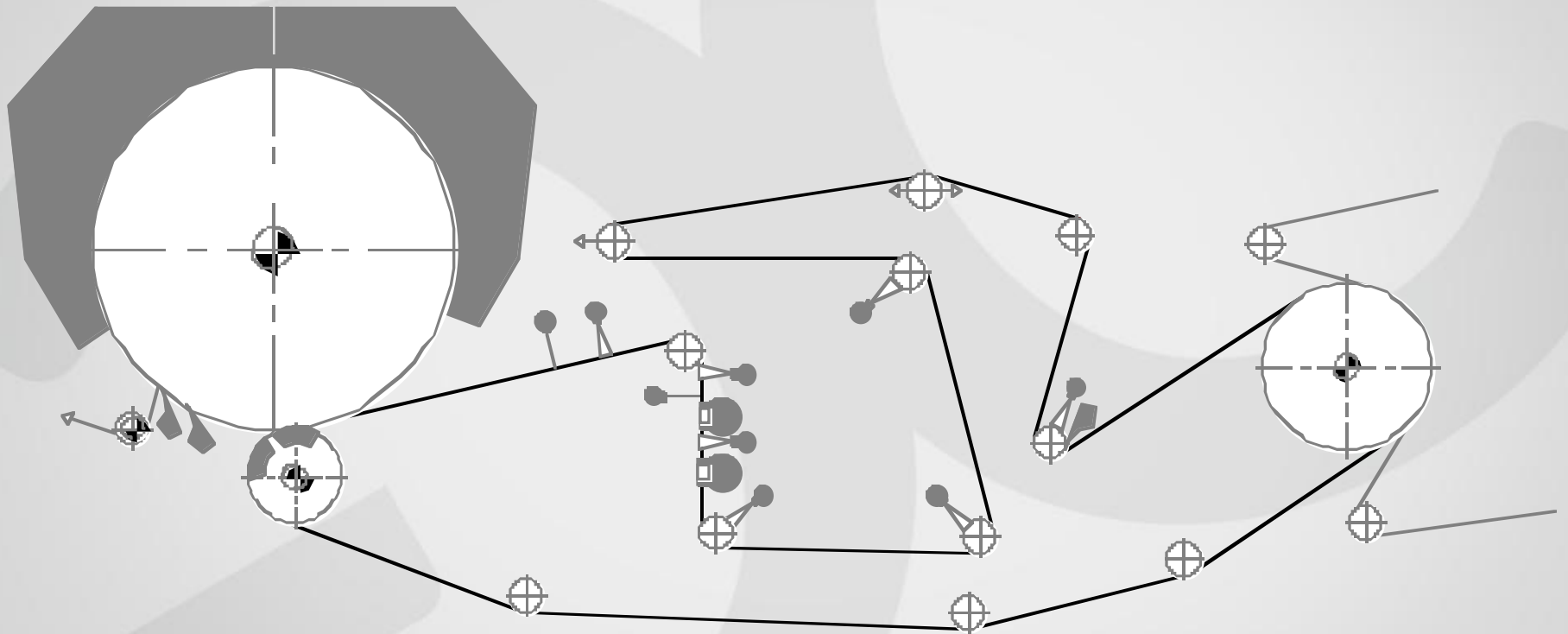

Suct. Drum, Baby Presses, 1st+2nd+3rd Main Press (Board)

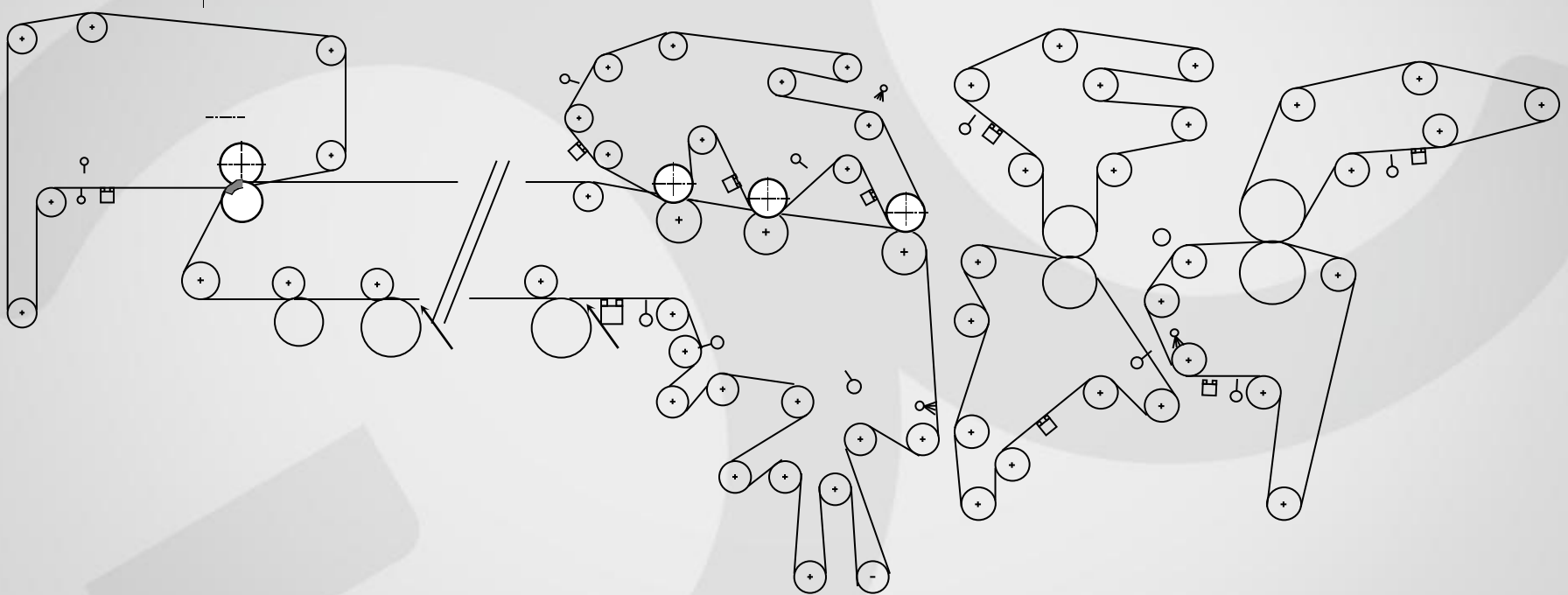

Pick-up, Tandem, 2nd Top (Liner/Fluting)

